

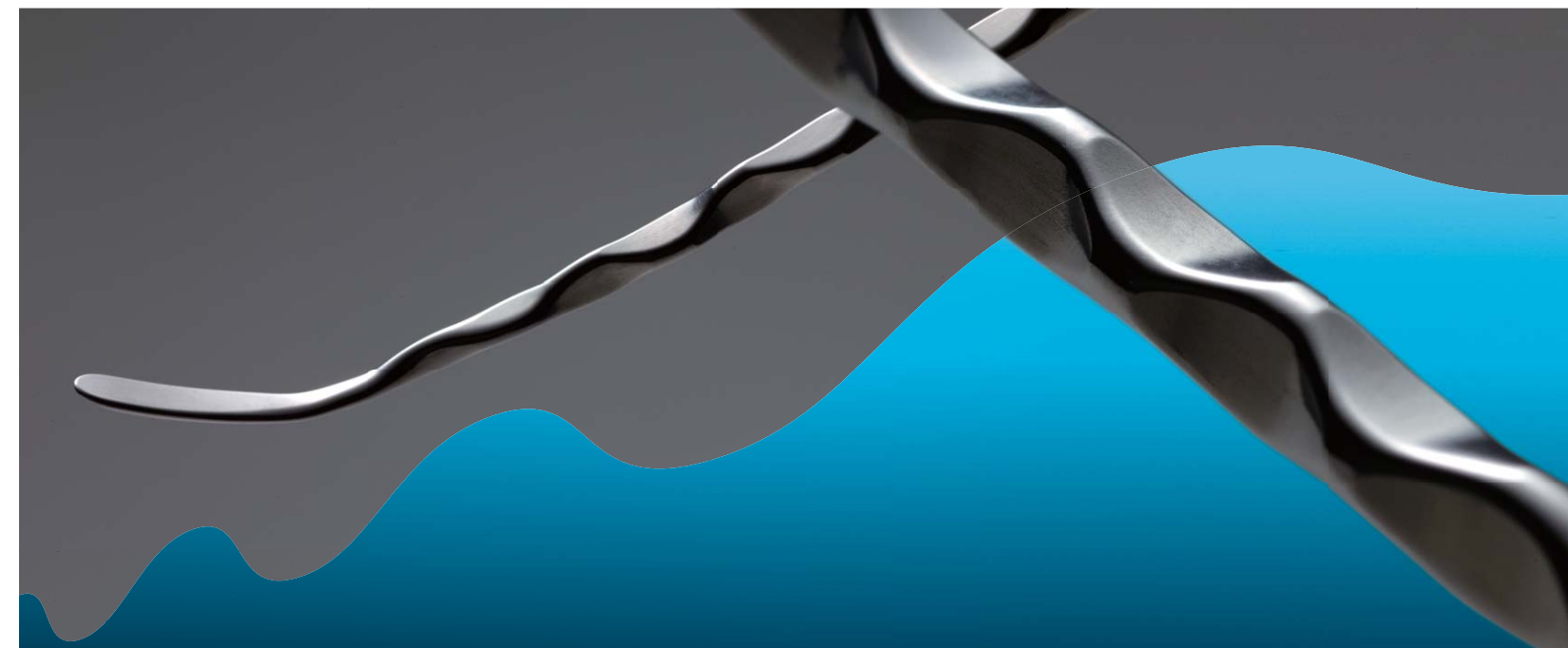

Mizuho Instruments for Keyhole Surgery

Malleable Instruments



 Caution	<ul style="list-style-type: none"> • Be sure not to use the product until you have carefully read the instruction manual and attached document and correctly understood their contents. • Be sure to carry out without fail the periodic inspections and the pre- and post-operative inspections. • For details about after-the-sale service be sure to inquire at our Sales Branches or the dealer from whom you have purchased this product.
---	---

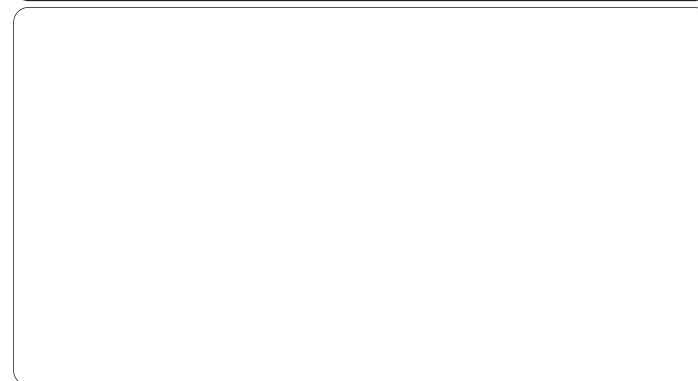

Mizuho America Inc.

30057 Ahern Avenue Union City, CA 94587
www.mizuho.com
P: 800-699-CLIP(2547)

Manufacturer
MIZUHO Corporation
Tokyo, JAPAN

* Under our policy, ongoing improvements and published specifications may be subject to change without prior notice.
* All published CG photos and illustrations have been from images.

Mizuho Instruments for Keyhole Surgery

Malleable Instruments

Mizuho Instruments for Keyhole Surgery Malleable Instruments

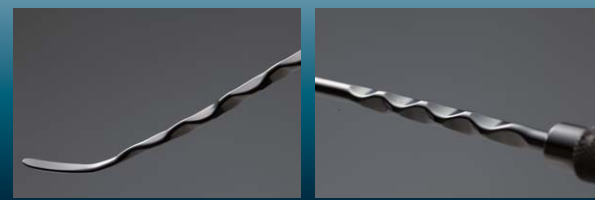

wave design

Multifaceted structure applied in two places on the shaft helps easiness in bending / straightening

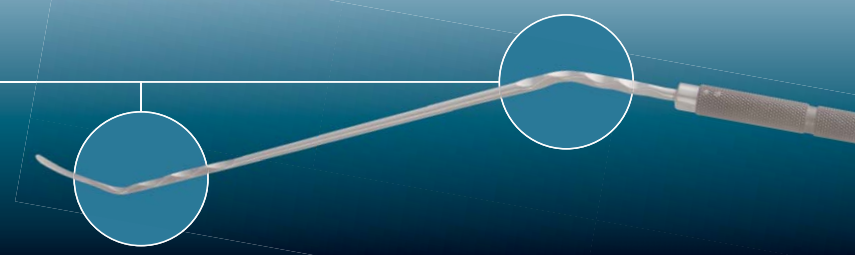

Malleable Dissector

Color of handle designed for easy identification (Blue for "Sharp" / Silver for "Dull")

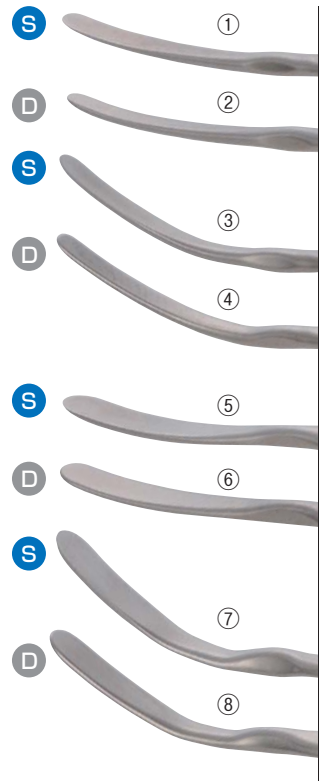
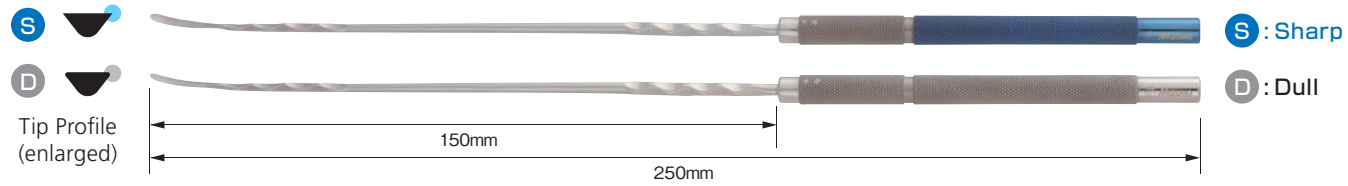

	Product Code	Product Name	Blade Width
①	07-794-41	Malleable Dissector, 1.5mm Sharp, Str.	1.5mm
②	07-794-42	Malleable Dissector, 1.5mm Dull, Str.	1.5mm
③	07-794-43	Malleable Dissector, 1.5mm Sharp, Cvd.	1.5mm
④	07-794-44	Malleable Dissector, 1.5mm Dull, Cvd.	1.5mm
⑤	07-794-45	Malleable Dissector, 2.5mm Sharp, Str.	2.5mm
⑥	07-794-46	Malleable Dissector, 2.5mm Dull, Str.	2.5mm
⑦	07-794-47	Malleable Dissector, 2.5mm Sharp, Cvd.	2.5mm
⑧	07-794-48	Malleable Dissector, 2.5mm Dull, Cvd.	2.5mm

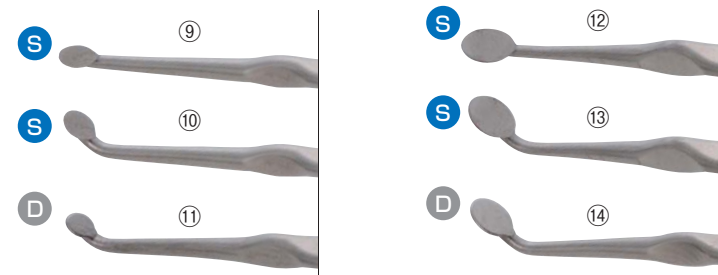

	Product Code	Product Name	Blade Width
⑨	07-794-51	Malleable Dissector, 2.0mm Round Plate, Sharp, Str.	2.0mm
⑩	07-794-52	Malleable Dissector, 2.0mm Round Plate, Sharp, Cvd.	2.0mm
⑪	07-794-53	Malleable Dissector, 2.0mm Round Plate, Dull, Cvd.	2.0mm
⑫	07-794-54	Malleable Dissector, 3.0mm Round Plate, Sharp, Str.	3.0mm
⑬	07-794-55	Malleable Dissector, 3.0mm Round Plate, Sharp, Cvd.	3.0mm
⑭	07-794-56	Malleable Dissector, 3.0mm Round Plate, Dull, Cvd.	3.0mm

Malleable Ring Dissector

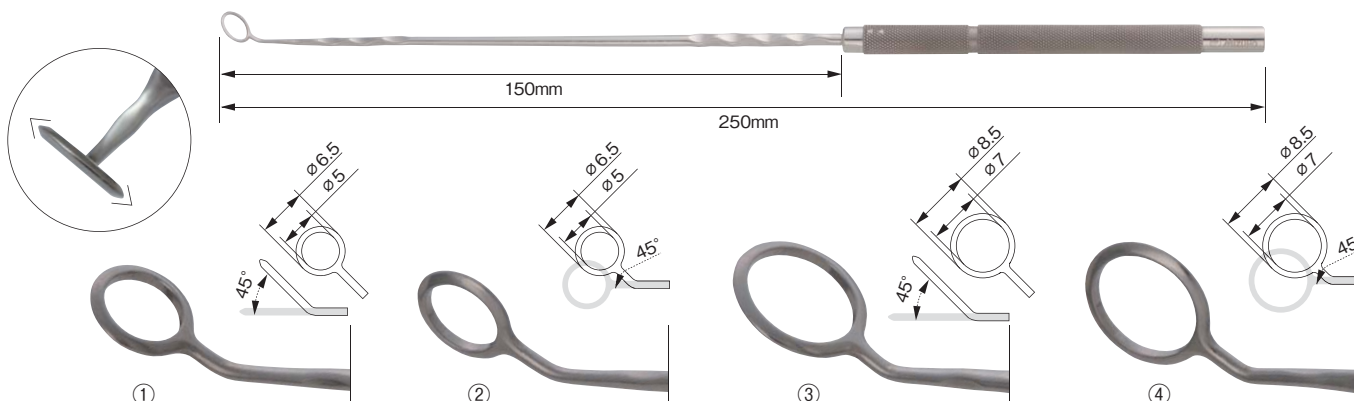

	Product Code	Product Name	Inner Diameter
①	07-794-61	Malleable Ring Dissector, 5.0mm Cvd, Up	5.0mm
②	07-794-62	Malleable Ring Dissector, 5.0mm Cvd, Sideway	5.0mm
③	07-794-63	Malleable Ring Dissector, 7.0mm Cvd, Up	7.0mm
④	07-794-64	Malleable Ring Dissector, 7.0mm Cvd, Sideway	7.0mm

Malleable Suction Tube

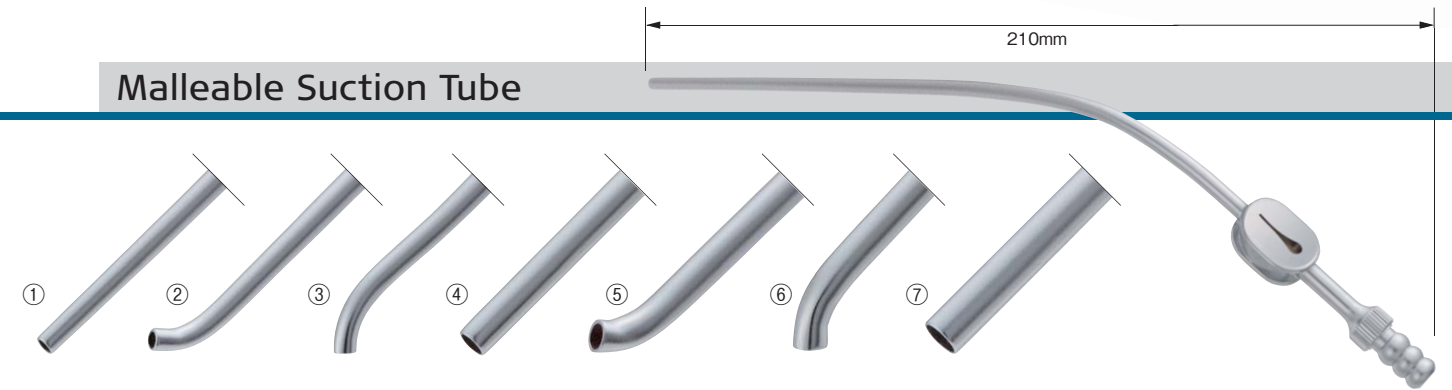

	Product Code	Product Name	Outer Diameter
①	07-794-91	Malleable Suction Tube, SUS, 6Fr, Str.	2.0mm
②	07-794-92	Malleable Suction Tube, SUS, 6Fr, Cvd, Up	2.1mm
③	07-794-93	Malleable Suction Tube, SUS, 6Fr, Cvd, Down	2.1mm
④	07-794-94	Malleable Suction Tube, SUS, 9Fr, Str.	3.0mm
⑤	07-794-95	Malleable Suction Tube, SUS, 9Fr, Cvd, Up	3.0mm
⑥	07-794-96	Malleable Suction Tube, SUS, 9Fr, Cvd, Down	3.0mm
⑦	07-794-97	Malleable Suction Tube, SUS, 12Fr, Str.	4.0mm

Malleable Sharp Hook

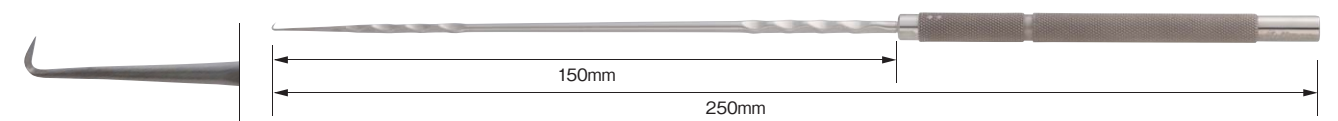

Product Code	Product Name
07-794-81	Malleable Hook, Sharp

Keyhole Ligation Instrument

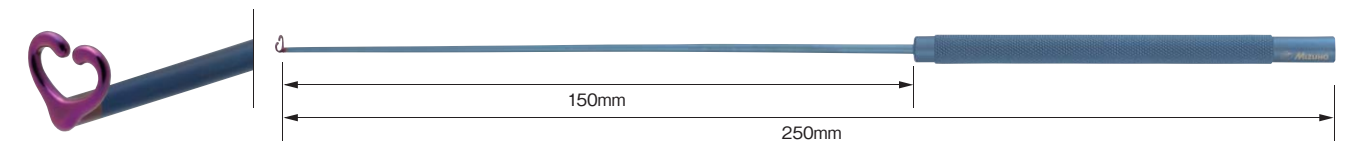

Product Code	Product Name
07-794-85	Keyhole Ligation Instrument

Keyhole Measure



Product Code	Product Name
07-794-87	Keyhole Measure